



LIGITEK ELECTRONICS CO.,LTD.
Property of Ligitek Only

LED SMD



Lead-Free Parts

TWO IN ONE

LG-192WK-DT-A06

DATA SHEET

DOC. NO : QW0905-LG-192WK-DT-A06

REV. : A

DATE : 03- Dec. - 2014



Package Dimensions

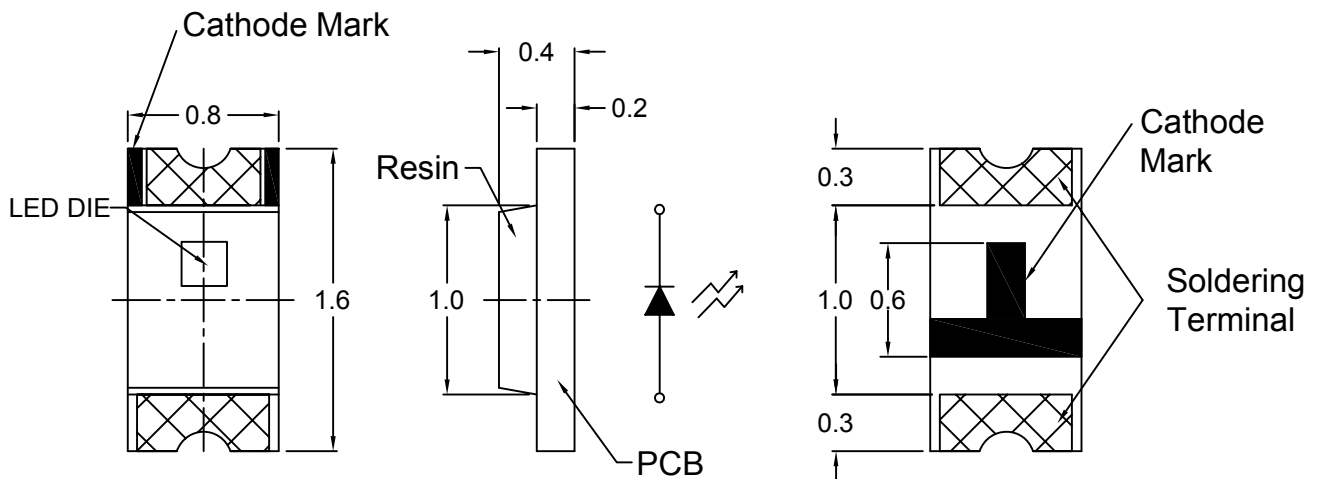

Note : 1.All dimension are in millimeter tolerance is $\pm 0.1\text{mm}$ unless otherwise noted.
2.Specifications are subject to change without notice.

Recommended Soldering Pad Dimensions

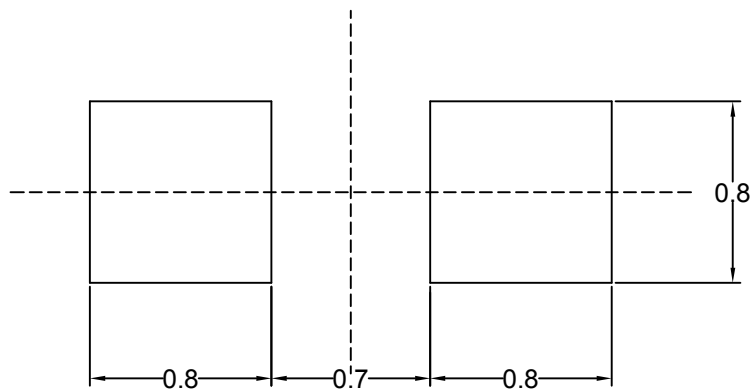

Note : The tolerances unless mentioned is $\pm 0.1\text{mm}$, Angle ± 0.5 . Unit=mm.

Absolute Maximum Ratings at Ta=25 °C

Parameter	Symbol	Ratings	UNIT
Power Dissipation	PD	72	mW
Peak Forward Current Duty 1/10@10KHz	IFP	100	mA
Forward Current	IF	20	mA
Reverse Current @5V	Ir	50	μA
Electrostatic Discharge	ESD	500	V
Operating Temperature	Topr	-20 ~ +80	°C
Storage Temperature	Tstg	-30 ~ +100	°C

Typical Electrical & Optical Characteristics (Ta=25 °C)

Items	Symbol	Min.	Typ.	Max.	UNIT	CONDITION
Luminous Intensity	Iv	125	250	----	mcd	IF=20mA
		50	80	----	mcd	IF=5mA ^{*4}
Chromaticity Coordinates	X	0.26	----	0.31	----	IF=20mA
	Y	0.225	----	0.34	----	IF=20mA
Spectral Line Half-Width	$\Delta \lambda$	----	30	----	nm	IF=20mA
Forward Voltage	V _F	2.8	----	3.6	V	IF=20mA
Viewing Angle	2θ 1/2	----	130	----	deg	IF=20mA

- Note :
- 1.The forward voltage data did not including $\pm 0.1V$ testing tolerance.
 2. The luminous intensity data did not including $\pm 15\%$ testing tolerance.
 - 3.The color coordinates measurement allowance is ± 0.01 testing tolerance
 - 4.Not the main test conditions.

Luminous Intensity Classification

BIN CODE	Iv(mcd) at20mA	
	Min.	Max.
R	125	200
S	200	320
T	320	500
U	500	800

Chromaticity Coordinates Specifications For Bin Grading

Color Coordiante at 20mA								
BIN CODE	1		2		3		4	
	X	Y	X	Y	X	Y	X	Y
B1	0.26	0.265	0.26	0.225	0.27	0.24	0.27	0.28
B2	0.27	0.28	0.27	0.24	0.28	0.255	0.28	0.295
B3	0.28	0.295	0.28	0.255	0.29	0.27	0.29	0.31
B4	0.29	0.31	0.29	0.27	0.3	0.285	0.3	0.325
B5	0.3	0.325	0.3	0.285	0.31	0.3	0.31	0.34

CIE Chromaticity Diagram

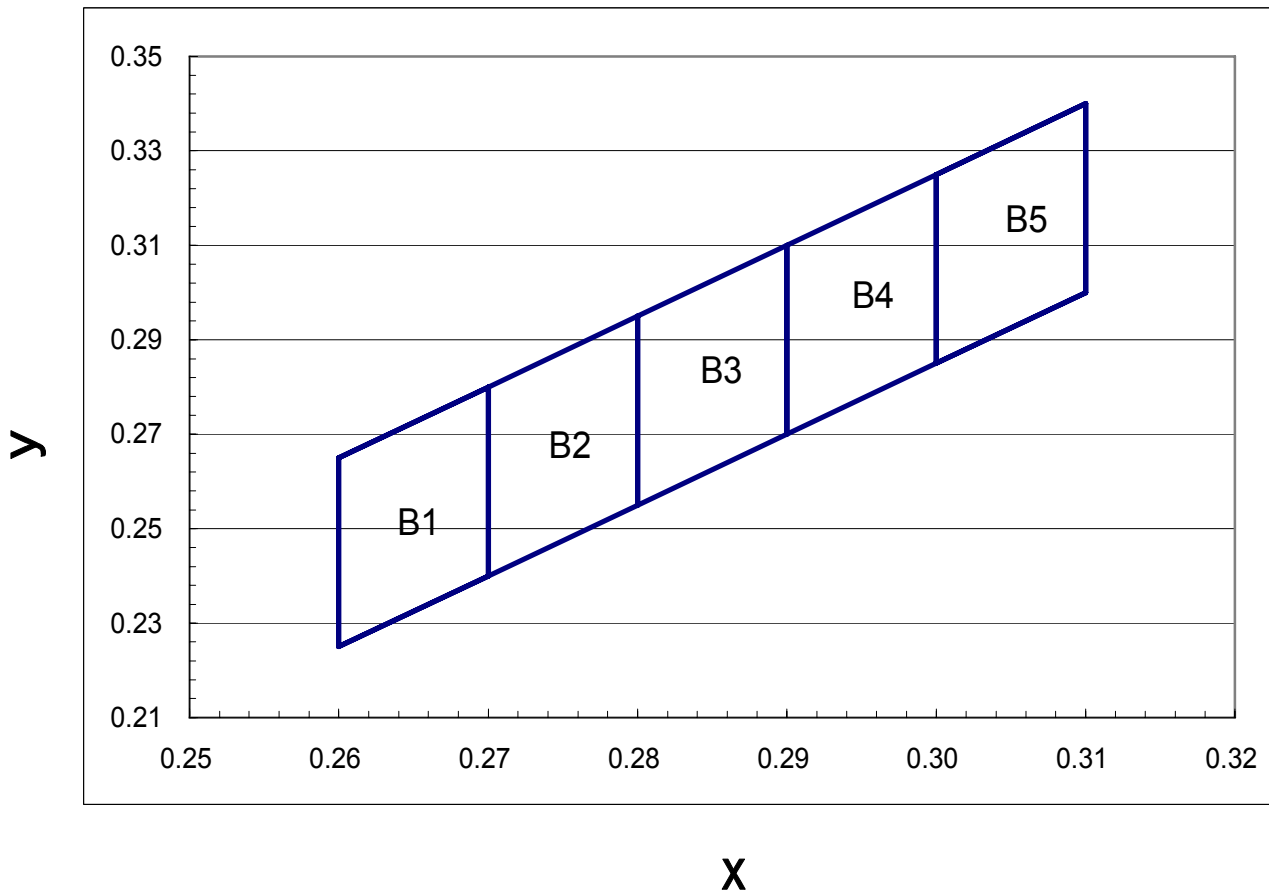

Typical Electro-Optical Characteristics Curve

WK CHIP

Fig.1 Forward current vs. Forward Voltage

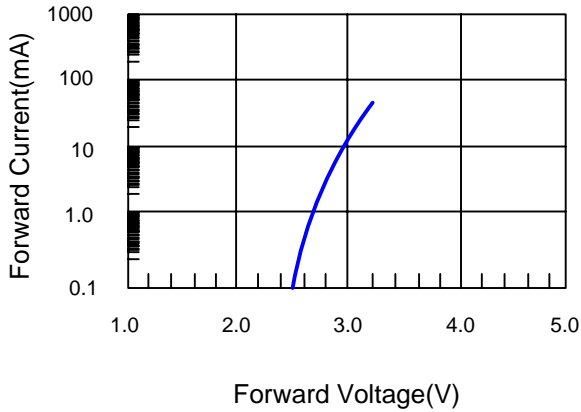

Fig.2 Relative Intensity vs. Forward Current

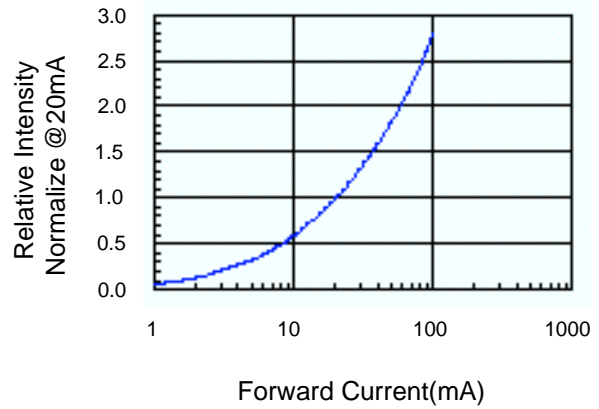

Fig.3 Forward Voltage vs. Temperature

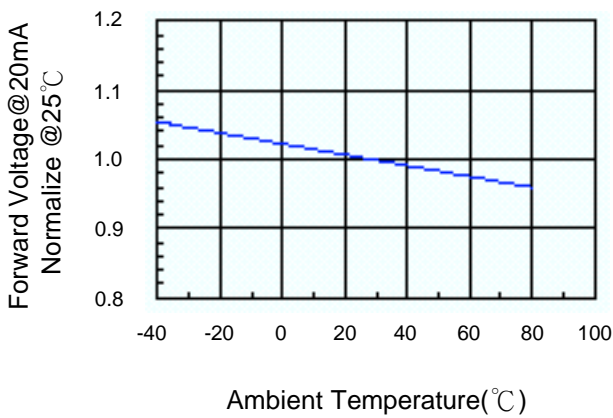

Fig.4 Relative Intensity vs. Temperature

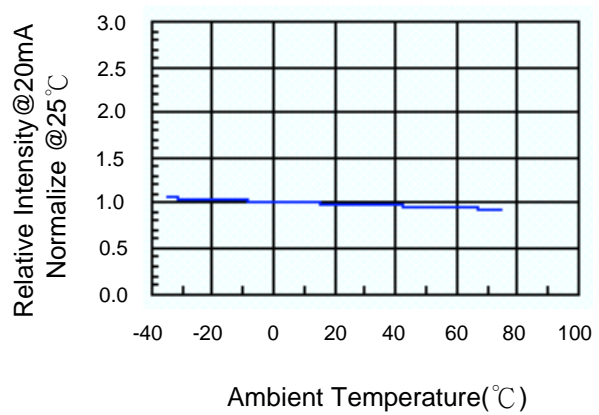

Fig.5 Luminous Spectrum (Ta=25°C)

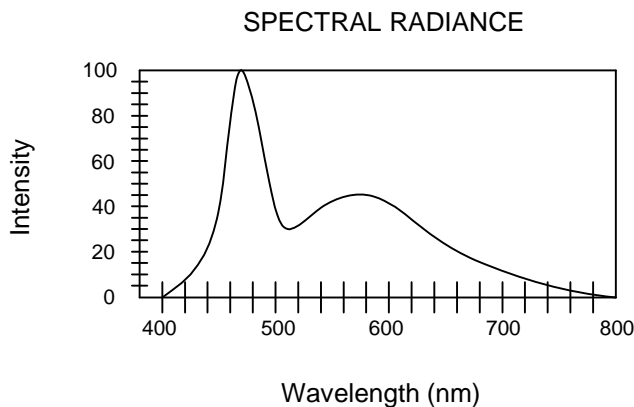
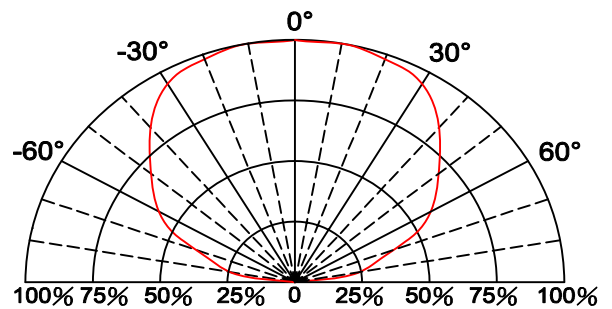
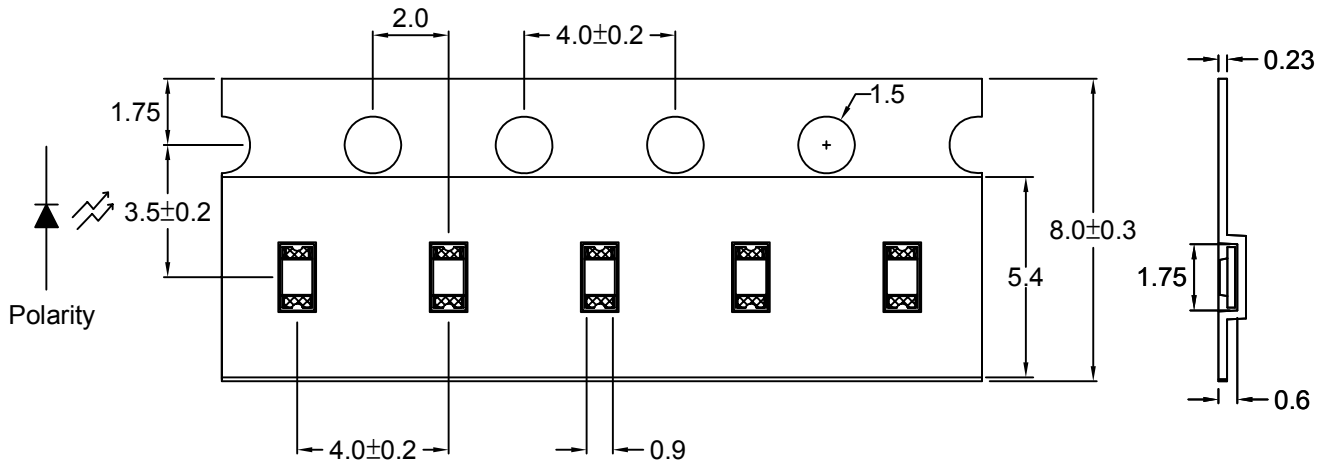

Fig.6 Directive Radiation



Carrier Tape Dimensions







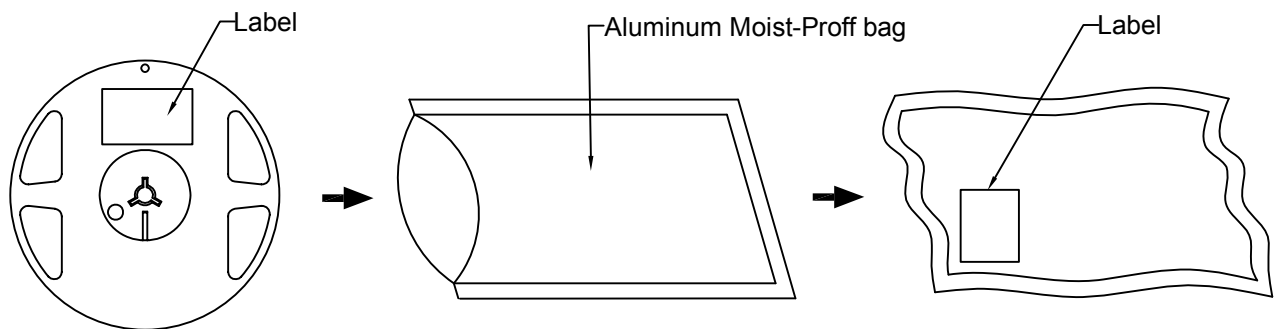

Note : The tolerances unless mentioned is $\pm 0.1\text{mm}$, Angle ± 0.5 . Unit=mm.

• Packing Specifications



Part No.	Description	Quantity/Reel
LG-192WK-DT-A06	8.0mm tape,7"reel	4000 devices

Label Explanation

	LIGITEK ELECTRONICS CO., LTD.	
		
	PART :	LG-192WK-DT-A06
		
	LOT :	GS114C0168
		
QTY(PCS):	4000	
		
BIN/HUE :	S/B1	VF:3.0-3.2

BIN : Luminous Intensity

HUE : Chromaticity Coordinates
(CIE_x , CIE_y)

VF : Forward Voltage

Reel Dimensions

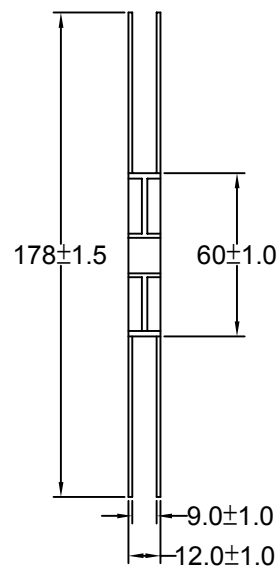
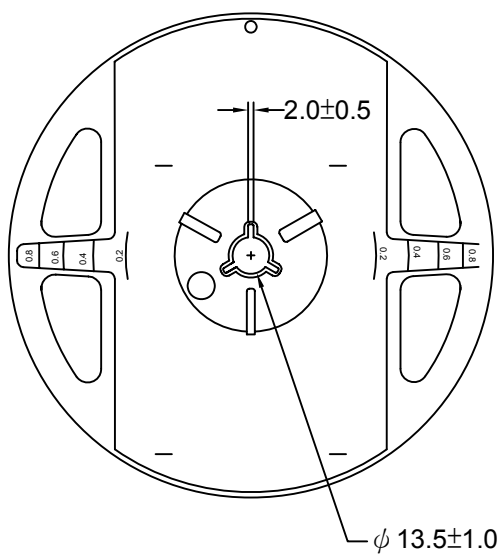

Box Explanation

1. 5 BAG / INNER BOX
2. INNER BOX SIZE : L X W X H 23cm X 8.5cm x 26cm

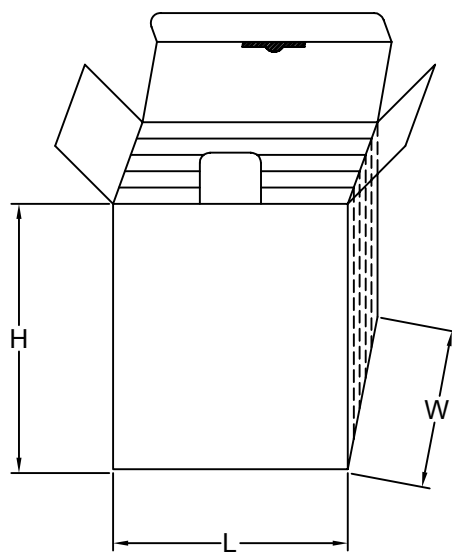

3. 10 INNER BOXES / CARTON
4. CARTON SIZE : L X W X H 58cm X 34cm x 35cm

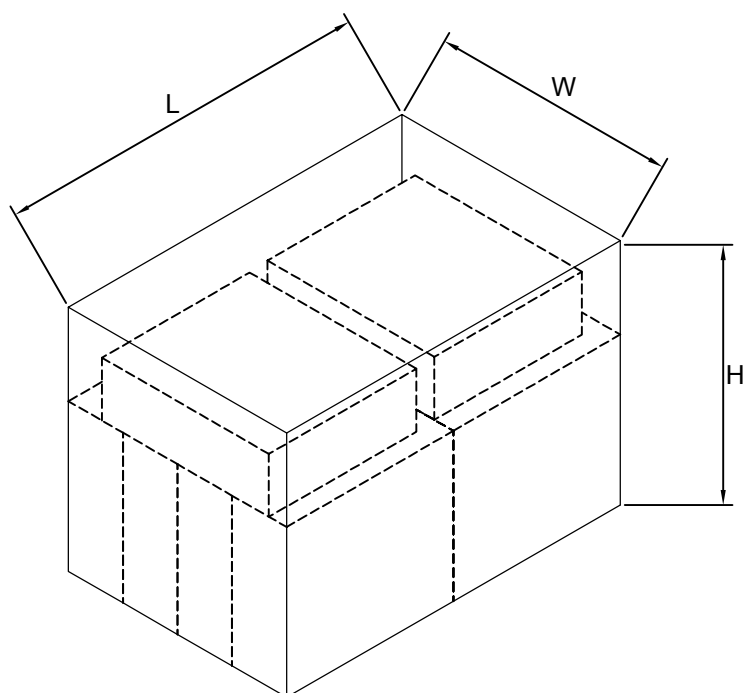

Recommended Soldering Conditions**1. Hand Solder**

Basic spec is $\leq 280^{\circ}\text{C}$ 3 sec one time only.

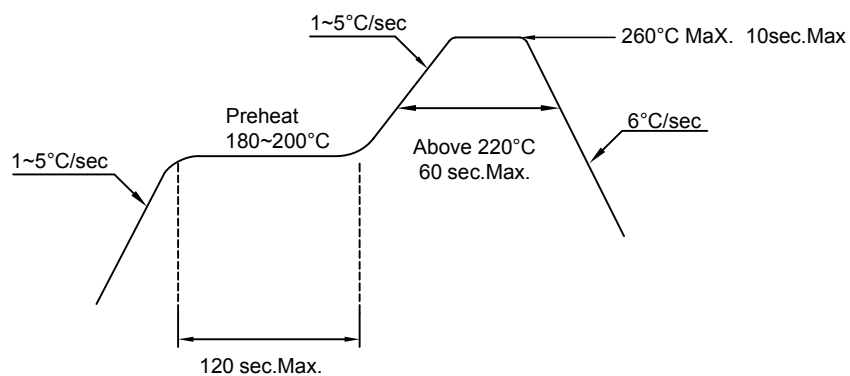
2. PB-Free Reflow Solder**Note:**

- 1.Reflow soldering should not be done more than two times.
- 2.When soldering,do not put stress on the LEDs during heating.
- 3.After soldering,do not warp the circuit board.

Precautions For Use:**Storage time:**

- 1.The operation of Temperatures and RH are : $5^{\circ}\text{C}\sim 35^{\circ}\text{C}$,RH60%.
- 2.Once the package is opened, the products should be used within a week.
Otherwise, they should be kept in a damp proof box with descanting agent.
Considering the tape life, we suggest our customers to use our products within a year(from production date).
- 3.If opened more than one week in an atmosphere $5^{\circ}\text{C} \sim 35^{\circ}\text{C}$,RH60%, they should be treated at $60^{\circ}\text{C}\pm 5^{\circ}\text{C}$ for 15hrs.

Drive Method:

LED is a current operated device, and therefore, requirer some kind of current limiting incorporated into the driver circuit. This current limiting typically takes the form of a current limiting resistor placed in series with the LED.

Consider worst case voltage variations than could occur across the current limiting resistor. The forward current should not be allowed to change by more than 40% of its desired value.

Circuit model A

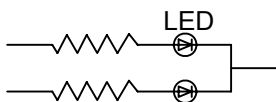

Circuit model B

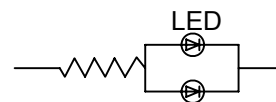

(A) Recommended circuit.

(B) The difference of brightness between LED could be found due to the VF-IF characteristics of LED.

Cleaning:

Use alcohol-based cleaning solvents such as isopropyl alcohol to clean the LED.

ESD(Electrostatic Discharge):

Static Electricity or power surge will damage the LED. Use of a conductive wrist band or anti-electrosatic glove is recommended when handing these LED. All devices, equipment and machinery must be properly grounded.

Reliability Test:

Classification	Test Item	Test Condition	Reference Standard
Endurance Test	Operating Life Test	1.Ta=Under Room Temperature As Per Data Sheet Maximum Rating. 2.If=20mA 3.t=1000 hrs (-24hrs, +72hrs)	MIL-STD-750D: 1026 MIL-STD-883D: 1005 JIS C 7021: B-1
	High Temperature Storage Test	1.Ta=105°C±5°C 2.t=1000 hrs (-24hrs, +72hrs)	MIL-STD-883D:1008 JIS C 7021: B-10
	Low Temperature Storage Test	1.Ta=-40°C±5°C 2.t=1000 hrs (-24hrs, +72hrs)	JIS C 7021: B-12
	High Temperature High Humidity Storage Test	1.Ta=65°C±5°C 2.RH=90%~95% 3.t=1000hrs; 2hrs	MIL-STD-202F:103B JIS C 7021: B-11
Environmental Test	Thermal Shock Test	1.Ta=105°C±5°C & -40°C±5°C (10min) (10min) 2.total 10 cycles	MIL-STD-202F: 107D MIL-STD-750D: 1051 MIL-STD-883D: 1011
	Solderability Test	1.T.Sol=235°C±5°C 2.Immersion time 2±0.5sec 3.Coverage ≥ 95% of the dipped surface	MIL-STD-202F: 208D MIL-STD-750D: 2026 MIL-STD-883D: 2003 IEC 68 Part 2-20 JIS C 7021: A-2
	Temperature Cycling	1.105°C ~ 25°C ~ -55°C ~ 25°C 30mins 5mins 30mins 5mins 2.10 Cyeles	MIL-STD-202F: 107D MIL-STD-750D: 1051 MIL-STD-883D: 1010 JIS C 7021: A-4
	IR Reflow	1.T=260°C Max. 10sec.Max. 2. 6 Min	MIL-STD-750D:2031.2 J-STD-020

